

# **ML7500 Series**

**BRIGHTFIELD AND DARKFIELD  
METALLURGICAL MICROSCOPES**

**INFINITY OPTICAL SYSTEM**

## **INSTRUCTION MANUAL**



**MEIJI TECHNO CO.,LTD.**

JAPAN

# ML7500 Series

MEIJI TECHNO

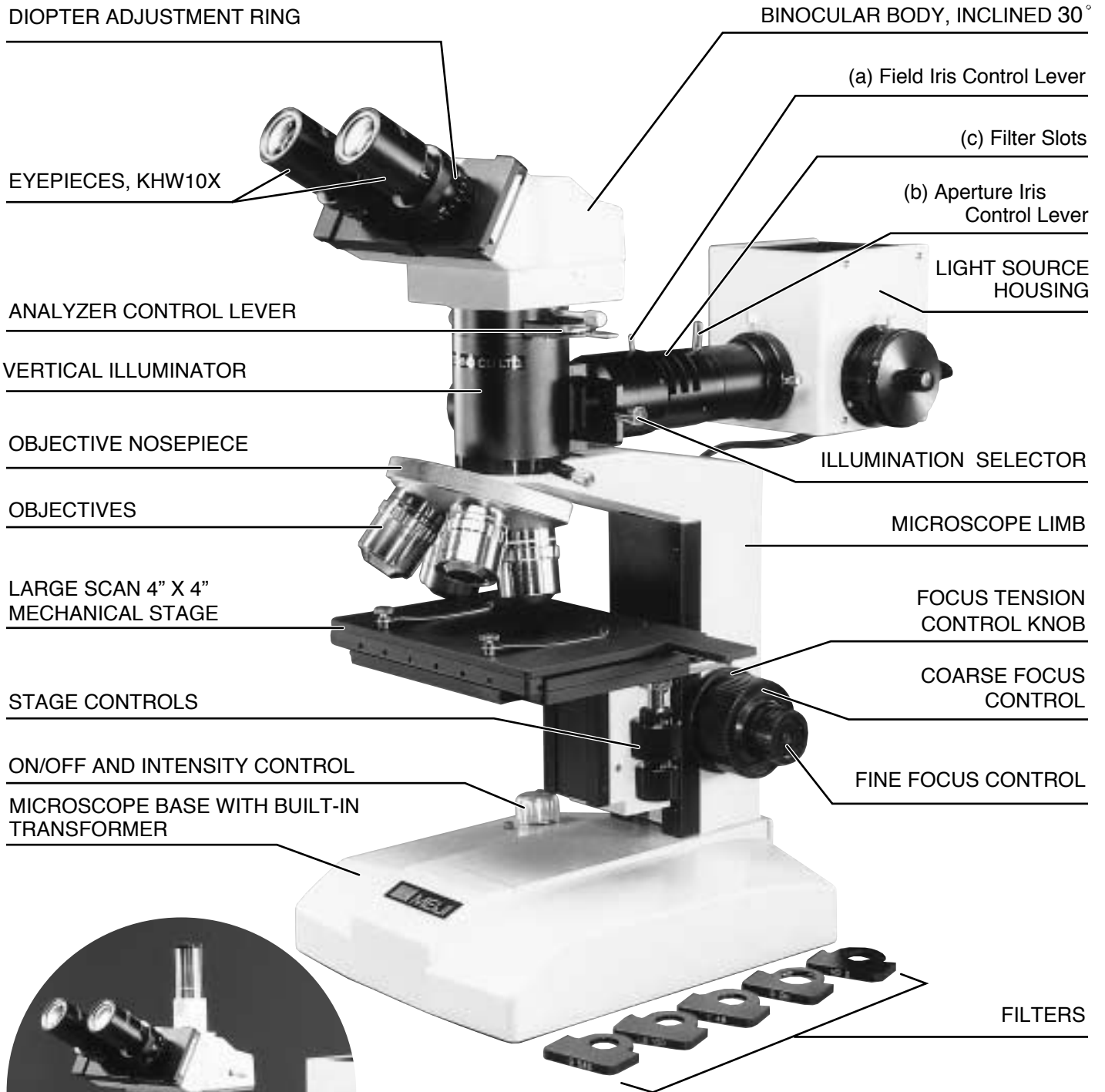

ML7530

ML7520

# ML7500 Series

MEIJI TECHNO

## UNPACKING, ASSEMBLY, PREPARATION FOR USE

### UNPACKING

All MEIJI TECHNO Microscopes are usually supplied in an expanded polystyrene, 2-part case and this should be used for storage, possible transport in the future, etc. If your order includes a wooden storage cabinet, release the fixing screws holding the limb and base from the cabinet and withdraw.

Unpack the microscope and its parts carefully. Do not throw away any boxes or packing materials until contents of the shipping container have been checked against your order and the packing list sent.

### ASSEMBLY

To mount the vertical illuminator (packed separately), loosen the clamp screw① and insert the cone fitting of the illuminator into the recess on the top of the limb and push the cone fitting toward and against the spring stopper② gently until the illuminator slips into the position and fasten it with the clamp screw①.

Now, the binocular or trinocular body can be mounted on the vertical illuminator.

To mount the body, loosen the clamp screw and insert the cone fitting of the body into the recess on the top of the illuminator and fasten it with the clamp screw③.

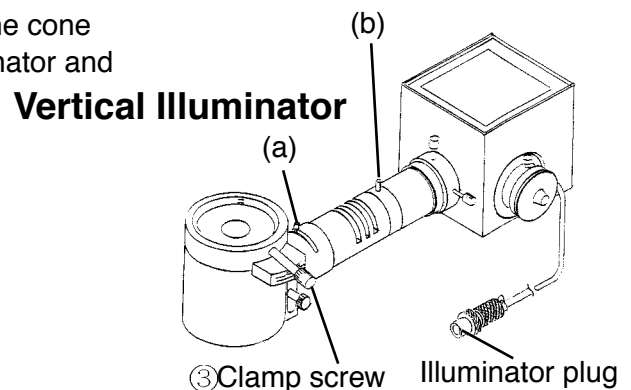
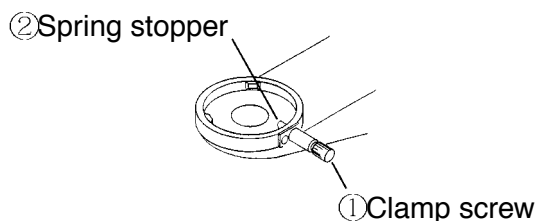

Place the microscope and parts on a sturdy table or desk which gives firm and stable support. This should be located in the atmosphere as clean as possible, avoiding the places where there is excessive dust, moisture, heat or fumes.

When in place insert eyepieces in the eyetubes of the binocular body and mount the objectives on the objective nosepiece, starting with the lowest magnification, then positioning the others to the right of the next lowest magnification objective.

### ★IMPORTANT!

Before plugging the illuminator into any electric outlet, make sure that transformers and illumination bases supplied to you are suitable to the current available. (See voltage indication given at the back bottom of the Limb.)

# BRIGHTFIELD AND DARKFIELD METALLURGICAL MICROSCOPES

MEIJI TECHNO 

## OPERATING INSTRUCTIONS

### OPTICAL SET-UP AND BRIGHTFIELD ILLUMINATION

After connecting the illuminator plug to the receptacle ⑤ at the back of the microscope base, please follow as indicated below:

[1] **Turn on the illuminator.** Place the specimen slide you wish to examine on the microscope stage and rotate the nosepiece to bring the 10X objective into position for focus.

[2] Make sure that both the field iris (a) and the aperture iris (b) are fully open.



⑤ Receptacle

[3] Slide the Illumination Selector to the central position where the middle Empty Hole comes across the Light Axis. This is the Brightfield Illumination.

### ILLUMINATION SELECTOR

SELECTOR LEVER

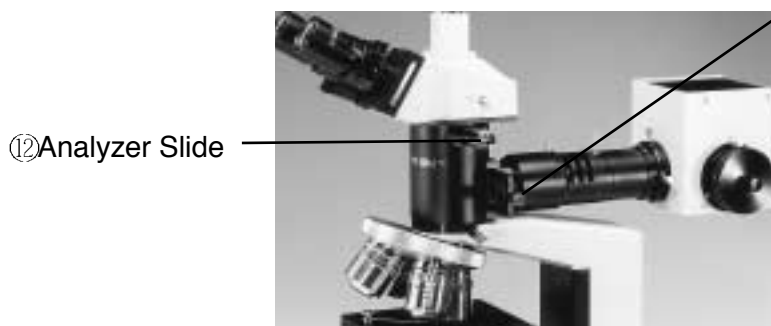

⑫ Analyzer Slide

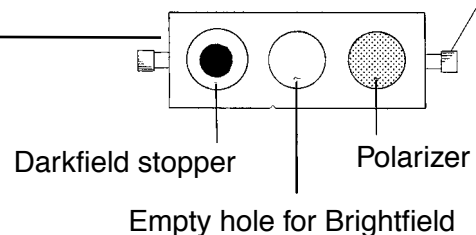

[4] Pull the Analyzer Slide ⑫ out to the full so the Analyzer gets out of the light path.

[5] Focus down on your specimen slide until surface detail can be seen. Adjust the brightness of the built-in light source, using the intensity control knob, left-hand back on the base.

### [6] BINOCULAR ADJUSTMENT

Comment: Using a binocular body is much more efficient and less tiring than monocular bodies, but it must be adjusted correctly. When it is perfectly adjusted the images coming from the two eyepieces are “fused” into one better image in eyes of the observer.

# ML7500 Series

MEIJI TECHNO

[7] After you have focused on the specimen, proceed as follows:-  
Move the sliders on which the two binocular eyepiece tubes are mounted in and out until the distance between them is exactly the same as the distance between the pupils of the observers eyes. (This is the “interpupillary distance”.)

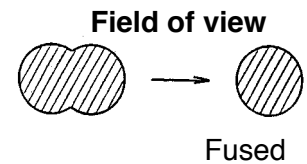

[8] When this is done, note the dimension which is displayed in the window ⑥ of the slider. Always remember to set to this distance when using the microscope. It will be different for different observers, so they will have to check the best setting for themselves.

[9] To get best focus with both eyes the eyetube heights should be adjusted to take into account the interpupillary distance mentioned [5] and [6] above. First, set the tube Length Adjustment Ring ⑥ to the reading which corresponds to the dimension shown in the binocular slider window. Do this for the left hand eyepiece only. Now focus to get the sharpest possible image in the left hand eyepiece, using the microscope fine adjustment. Then turn the right hand Tube Length Adjustment Ring until the image is equally sharp in the viewer's right eye. As these Rings function also for dioptric correction the dimension set may not, in this case, exactly correspond to the window's indication.



[10] Now turn the field iris adjustment lever(a) until the field iris is seen in the field of view.

[11] Your light source may require centering adjustment if the field of view seems unevenly illuminated. Centering controls are located on the side of the light source housing which is built in at the back of the vertical illuminator.

## [12] CENTERING ADJUSTMENT

To move the bulb vertically, loosen Clamp Screw ⑦ and turn the Backing Plate ⑧ clockwise or counterclockwise slightly.

To move the bulb horizontally, turn the Lamp Centering Control ⑨.

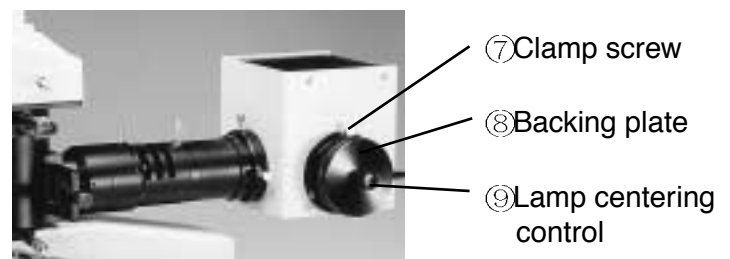

[13] Close down the field iris (using the lever(a) on the vertical illuminator) until the image of the field iris is in focus on the specimen. Then open it back out until the image of the iris disappears from the field of view.

[14] Now adjust the aperture iris (using lever(b) on the vertical illuminator), closing it down slowly while observing the field of view. A point will be reached where there is a sudden distinct drop in brightness of the field of view. When this occurs, open up the iris slightly, just until this brightness condition reverses, but no more.

[15] This procedure should be followed each time objectives are changed.

# BRIGHTFIELD AND DARKFIELD METALLURGICAL MICROSCOPES

MEIJI TECHNO 

## DARKFIELD ILLUMINATION SET UP

The reflective Darkfield Illuminator is designed as shown here:

As the above illustrates, the light does not pass the objective directly and illuminate the specimen with the light bundle inclined against the light axis, and observation is made possible only through scattered or refracted light.

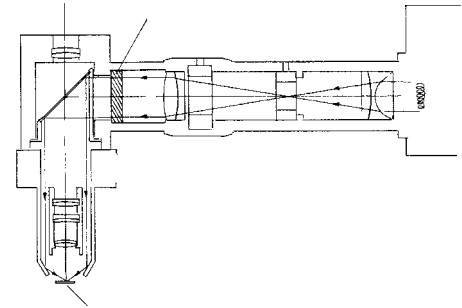

When you observe flat surface of glass or mirror, you will see nothing in the dark. But, when you observe a specimen which includes refractive substance to scatter light, the clear image of the substance can be seen.

[1] Slide the Illumination Selector to the position where Darkfield stopper comes across the Light Axis centrally.

[2] Open up both irises for Field(a) and Aperture(b).

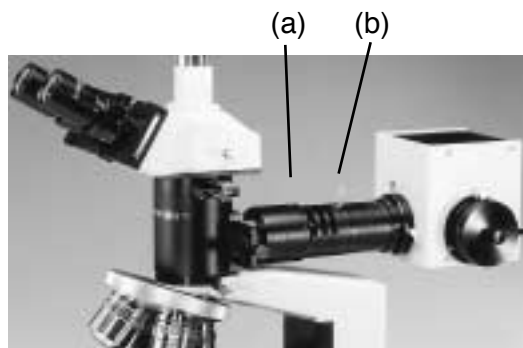

### Illumination Selector

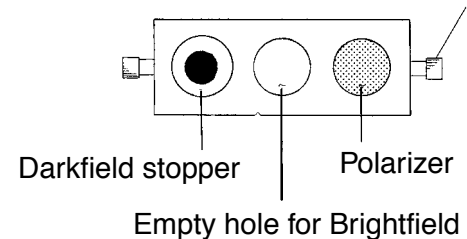

[3] Focus down on the specimen just in the same way as for the Brightfield observation. (The image is observed in a different way from that of the Brightfield observation. That is, we can see an image formed from light scattered by features in the object, the detail thus appearing bright against a dark background.)

[4] Brightness of illumination can be adjusted by Intensity Control knob, just in the same way as for the Brightfield observation.

## POLARIZING FACILITY

### POLARIZER

Slide the Illumination Selector to the position where Polarizer comes across the Light Axis centrally.

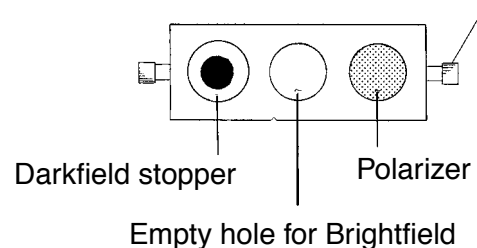

# ML7500 Series

MEIJI TECHNO

## SLIDE-IN ANALYZER

The Analyzer<sup>⑫</sup> is mounted in an in-tube slider which moves the analyzer in and out of the optical path and rotates between 0° and 90° by the lever<sup>⑬</sup>. When “in” and at 45° position, and with the Polarizing filter in position, these elements are said to be “crossed” and the field of view is said to be

“extinguished”. In this condition the field of view is dark - except for optically active elements in the field, which rotate the angle of polarization and thus become visible against a dark background.

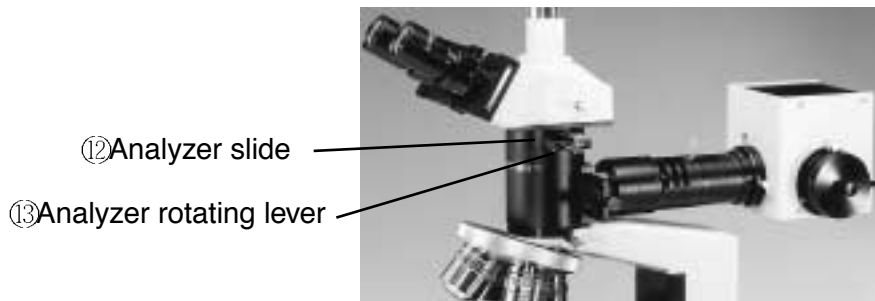

## TENSION CONTROL

The tension control knob<sup>⑭</sup> is provided to allow the individual user to adjust the focus tension to his/her own preference. Tension may be increased by turning the knob with a counterclockwise motion. A lighter tension may be set by turning clockwise.



## PHOTOGRAPHY AND TELEVISION

### PHOTOGRAPHY

Photographic documentation of microscope visual images is most conveniently achieved by using the trinocular (photo-binocular) bodies for use with 35mm SLR Camera or PMX100 Large Format Camera.

In the case of the ML series of biological, metallurgical and polarizing microscopes a trinocular body is equipped with a sliding switch-over beam-splitter component which either (1) allows all of the light to go to the visual eyepieces or (2) directs 80% of the image-forming light upwards to the film plane of a 35mm SLR camera, while still sending 20% of the light to the binocular eyepieces.

In the system the MA150/50 or MA150/60 Camera Attachment should be used with the SLR camera of your choice. Please note that one of the large range of T2 Adaptor Rings suiting to your camera should be ordered separately.

These adaptor rings are intended to compensate for the small differences in effective distance of the film plane in your camera - so as to ensure that photographs are optimally sharp, and achieved without wastage of film in trial shots and experimentation.

# BRIGHTFIELD AND DARKFIELD METALLURGICAL MICROSCOPES

MEIJI TECHNO 

In addition special low-power camera eyepieces (2.5X, 3.3X and 5X) are available and recommended - these will give you maximum field coverage on your specimen while using the convenient and economical 35mm film format.

## CAMERA OPERATION

[1] Fix your 35mm SLR camera, T2 Adapter and a photo (camera) eyepiece on the MA150/50 or MA150/60 Camera Attachment, then mounting this assembly on the straight tube of the trinocular body.

[2] Pull out the lever on your trinocular body so as to send the image both to the camera and the visual eyepieces.

[3] Rotate the adjustment ring on the straight tube so as to set correctly for optimum conditions of simultaneous visual observation and photography.

## TELEVISION

For television the MA151/10 "C" Mount should be used, threaded into your TV camera, then placed and adjusted on straight tube of your trinocular body.

Adjustment can then proceed as per paragraph [3] above. You should understand that the comparatively large magnification factors inherent in most TV camera/monitor systems will restrict your field of view (while blowing up total magnification).



A correct optical set-up and adjustment is, of course, crucial to obtaining a good TV monitor image, but keep in mind that the monitor controls for brightness and contrast adjustment are also important and should also be experimented with in order to obtain the best monitor image.

## MAINTENANCE AND CARE

### BULB REPLACEMENT

When changing light bulbs in the illuminators, always disconnect the plug from the electrical source. Never work on the electrical system without first disconnecting.

The bulb is held in a socket block inserted in the light source housing at the back of the incident illuminator.

[1] To remove the socket block from the light source housing, loosen the Clamp Screw  and turn the Backing Plate  clockwise to the slot. Then pull out the Backing Plate  from the light source housing.

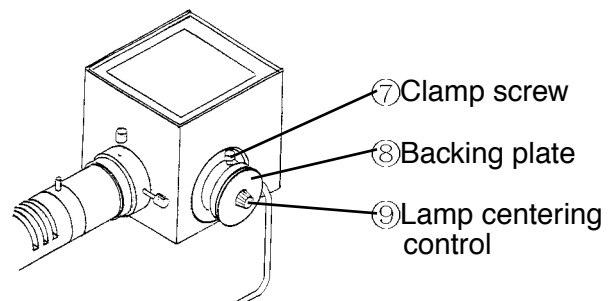



# ML7500 Series



[2] After making certain the old bulb is cool to the touch, remove it by pulling straight out of its socket. Do not twist as the lamp pins may break off and become lodged in the socket.

[3] Handle the new bulb only with tissue paper or the plastic in which it is wrapped and insert the two pins into the two holes in the socket.

**DO NOT HANDLE WITH BARE FINGERS - BULB MAY EXPLODE WHEN HEATED IF NOT HANDLED CORRECTLY.**

## **CARE**

Always cover the instrument with plastic dust cover provided when the microscope is not in use.

Keep eyepieces in the microscope body at all times in order to prevent dust from falling on the internal optics.

Store the microscope in a safe, clean place when not in use for an extended period of time.

## **CLEANING**

Clean exposed lens surfaces carefully with a pressurized air source, soft brush or clean soft cloth. Too much finger pressure may damage lens coatings.

To remove oil, fingerprints and grease smudges, use the cleaning cloth moistened with a very small amount of alcohol or xylene.

Immersion oil should always be promptly cleaned from high power oil immersion objectives after every use.

Painted or plastic surfaces should be cleaned only with a cloth moistened with water and a small amount of detergent.

**DO NOT ATTEMPT TO MAKE ADJUSTMENTS TO THE INTERNAL OPTICS OR MECHANICS!!**

If the microscope does not seem to be functioning properly or you have questions about its operation, call your supplier (or/and authorized repair service) for advice.



**MEIJI TECHNO CO.,LTD.**

6, Oi-670, Oi-machi, Iruma-gun  
Saitama 356-0053, Japan  
Phone : 492-67-0911  
Fax : 492-69-0691, 492-69-0692

**MEIJI TECHNO AMERICA**

2186 Bering Drive  
San Jose, CA., 95131, USA  
Phone : 408-428-9654 Fax : 408-428-0472  
Toll free : 800-832-0060



**www.MicroscopeWorld.com**  
**800-942-0528 US Toll Free**  
**760-438-0528 International**  
**info@microscopeworld.com**